

A Bi-Directional Optical Time Domain Reflectometry Technique Optimised for Short LAN Fibers.

N. D. Channon - Megger Limited, Dover England
A. G. Hallam - Halcyon Optical Services, Southampton England

Abstract: A process for constructing bi-directional OTDR traces is demonstrated that is better suited to the short fibers installed as part of local area networks (LANs). Reflections are eliminated from the processed trace and no fiber is obscured by dead zones.

Introduction

The optical time-domain reflectometer (OTDR) is a useful tool for characterising the losses along an optical fiber because it is a distributed measurement and the resulting trace represents the local loss at any point in the fiber. This loss is simply the gradient of the trace at the distance along the fiber or the magnitude of the step across an event such as a splice or connector.¹ The validity of these loss measurements depends on the consistency of the fiber before and after the event. They are only valid if the fiber used on both sides of an event is of the same physical construction and chemical composition. Bi-directional techniques, where an OTDR trace is obtained from both ends of the fiber, offer a way to combine the data into a more precise, and less fiber dependent measurement, of loss.² However, the conventional technique obscures useful data around each connector whereas the technique described here demonstrates an enhanced processing method that avoids this problem.

Conventional OTDR Measurement on a Duplex LAN fiber.

In LAN applications where the fiber under test (FUT) is duplex (two fiber cable) it is convenient to perform bi-directional measurements by attaching a loop-back patchcord at the far end of the link then measuring the resulting loop in both directions by shifting the OTDR between the duplex fibers.

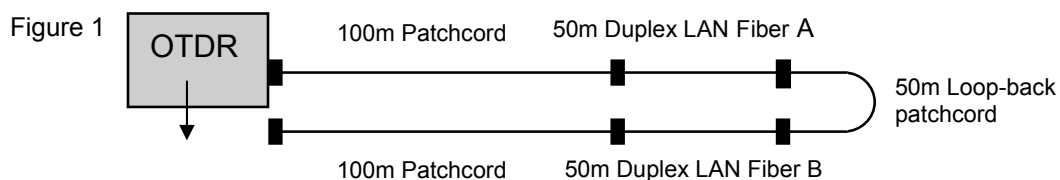

Figure 1 shows a 50m LAN fiber segment connected to an OTDR with a 100m duplex patchcord. A 50m loop-back patchcord has been attached to the far end and the resulting loop measured in both directions. Figure 2 shows the resulting OTDR traces with Trace B flipped so that the distance axis represents the same section of fiber on both traces. (It can also be seen from these traces that this FUT has a severe loss caused by a tight bend in it; a typical fault caused by poor installation)

When Trace A is examined, Figure 3, the connector between the launch patchcord and the FUT appears to have a negative loss of 0.03dB across it. However, the same connector, when measured in the reverse direction (Trace B) appears to have a loss of 0.07 dB shown in Figure 4 by the step down in power.

The problem is not unusual in the LAN environment and arises because the FUT and the loop-back are from different manufacturers of fiber and have slightly different optical properties such as numerical aperture. In the case of the Trace A, more scattered light is returned to the OTDR after the connector than before it giving rise to what is known as a "gainer". The correct loss, the one that would be most likely to agree with a Light Source – Power Meter (LSPM) measurement, is probably the average of the two directions.³ Bi-directional analysis is one way to achieve this.

Figure 2

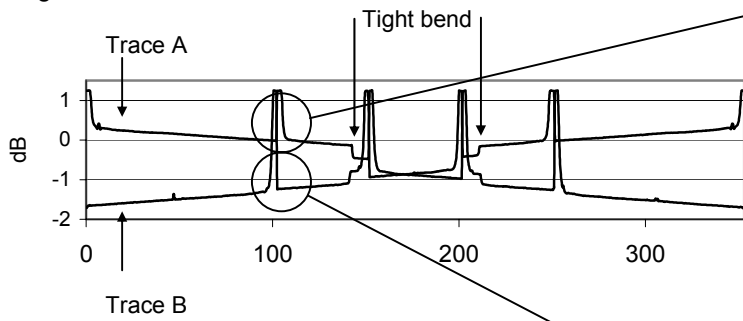
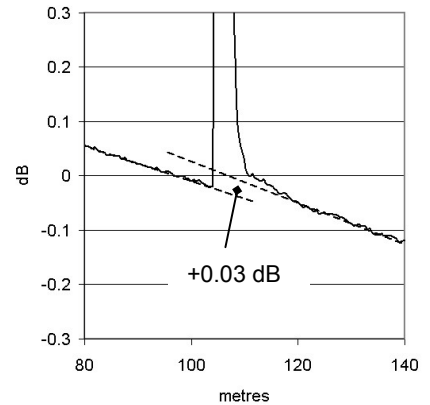

Figure 3



Conventional bi-directional processing proceeds by inverting Trace B, Figure 5, then taking the mean power of the two traces. The resulting trace is shown in Figure 6.

Figure 5

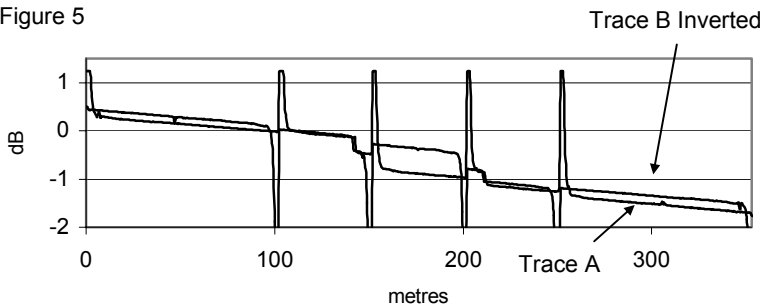
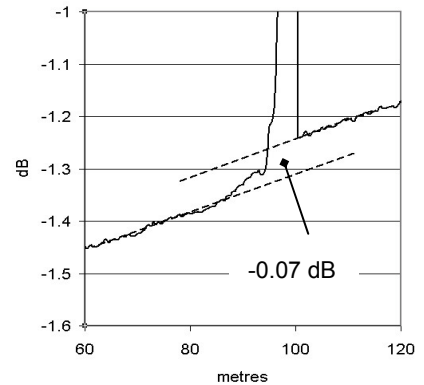

Figure 4



Although the connector and other event losses are successfully averaged the trace around every connector is obscured for a length equivalent to twice the attenuation (non-reflective) dead zone that is typically several metres. In LAN situations this can be a significant proportion of the FUT and in an area where statistically there is a high risk of faults such as breaks and tight bends.

Figure 6

Averaged connector loss (0.05dB) but trace detail lost around the connector caused by attenuation dead zones.

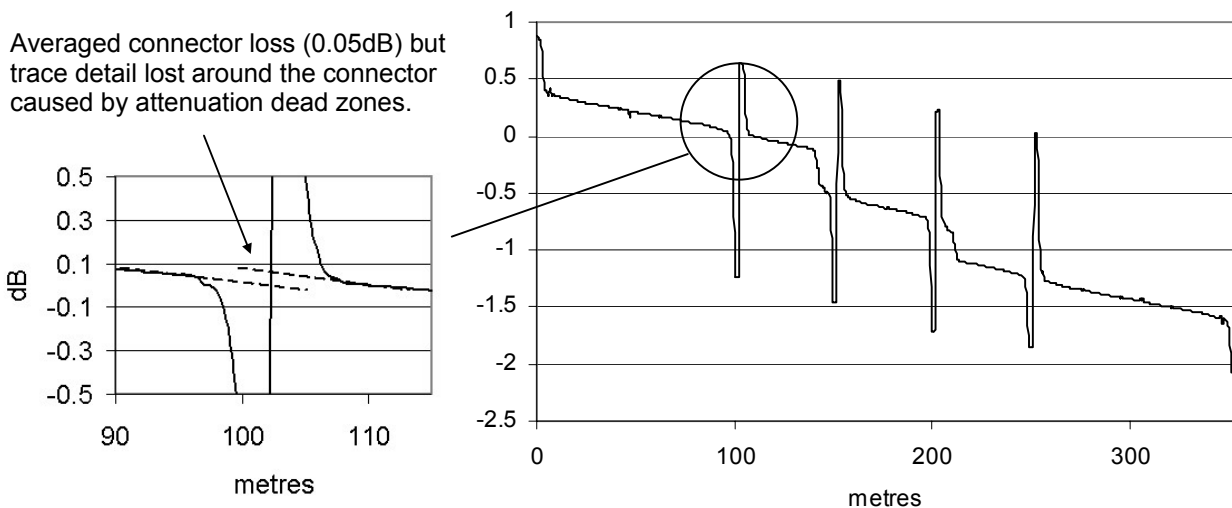

Resulting bi-directional trace of the LAN fiber loop shown in Figure 1. (Conventional process)

An Improved Processing Method

In the process of measuring the initial traces used in this bi-directional measurement the OTDR has gathered information right up to the connector interface in both directions and this can be used to construct a better bi-directional trace by the following method.

The two traces A and B are measured in the same way. Trace B is reversed and by using a simple correlation technique shifted to obtain the best alignment of the leading edges of the connector peaks. This removes any error caused by the reported 'zero' distance not aligning with the start of the fiber. Where a peak does not correlate with that measured in the reverse direction it indicates that there is a break close to that connector and its exact position computed. This is described more fully later. Trace B is then inverted as shown in Figure 7.

A point, the "switch point" is selected within every fiber segment of the trace. It need not be the mid-point but should be clear of any dead zone or events such as splices or bends. Simple detection algorithms may be used to select a suitable point. In the example below, the mid-point (50%) is the default choice but it is moved to the 40% or 60% distance points if the data quality (peak to peak variation) is better at one of these other positions. (The third switch point below is shifted to avoid a small ghost reflection.) The mean power between the two traces is computed at these points and the offset of each trace from that mean.

Figure 7

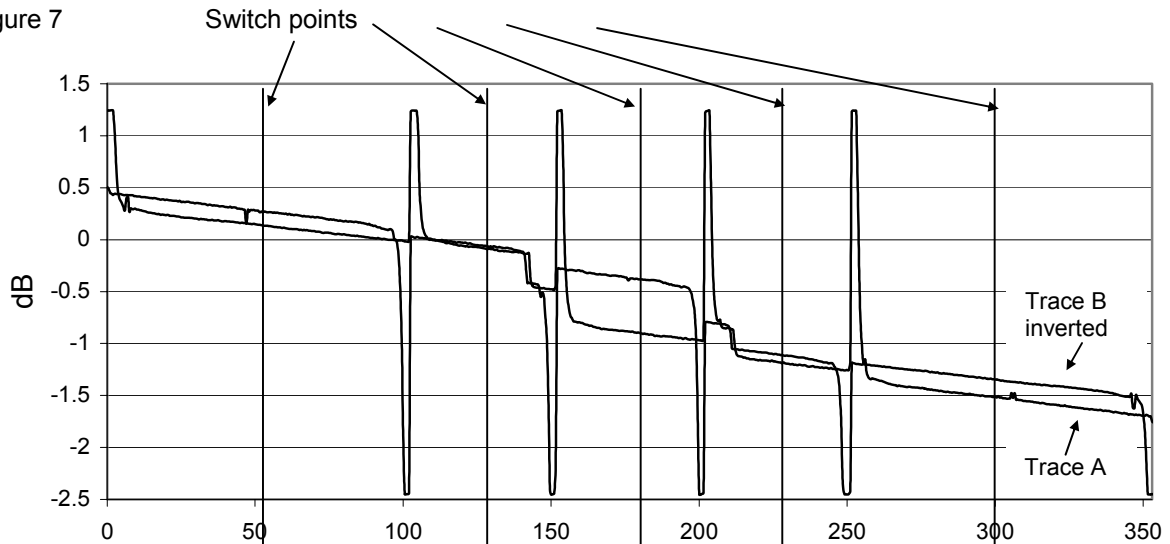

Trace used	B	A	B	A	B	A	B	A	B	A
------------	---	---	---	---	---	---	---	---	---	---

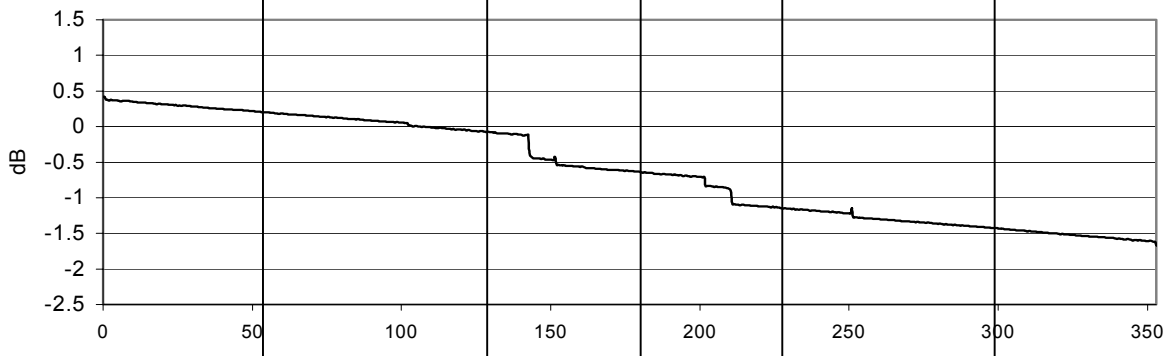

Resulting bi-directional trace of the LAN fiber loop shown in Figure 1. (Improved process)

Construction of the bi-directional trace comprises selecting the data from the segment portion between the connector and the switch point from Trace A or B, whichever is not obscured by dead zone, and shifting it by the appropriate offset towards the switch point mean. The resulting trace is shown in the lower section of Figure 7. The loss across every connector is therefore averaged and none of the trace is obscured by reflection and dead zone corruption.

Ghosts reflections may show on the bi-directional trace as positive or negative peaks, or may disappear completely, depending on their position relative to the switch points. However, by examining the original traces and the processed trace, ghosts are very easily identified.

There are limitations to this technique. The most important is that any fiber segment must be longer than twice the event dead zone of the OTDR. Segments shorter than this must be identified by the analysis software and appropriately marked. The loss across these short segments is still accurately averaged and the length is measured. Figure 7 shows two connectors, 13m apart, in a 370m length of fiber. The total loss across both connectors and the 13m fiber is averaged in the processed trace. The exact position of both connectors is measured from the correlation result and displayed by artificially setting the trace to a default (arbitrary) value -2dB . This indicates that there is no valid information available for the fiber between the two connectors. The method can therefore measure events that are very close together and is only limited by the sampling resolution of the OTDR.

Figure 7

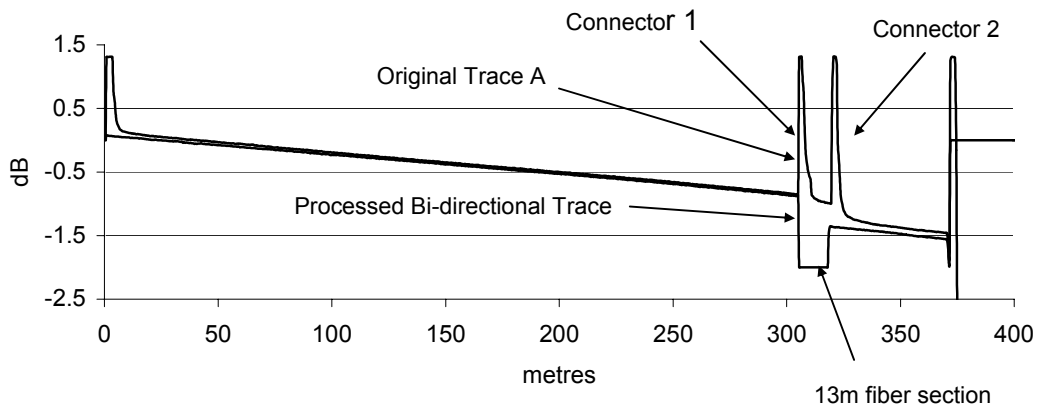

A second limitation is that losses within a segment such as the tight bend shown in Figure 2 are not averaged but will be shown as in one of the original traces. This is generally not a large error since bends, by their nature, comprise the same fiber both sides of the loss and are represented accurately in both directions. Note that no bi-directional trace technique will reliably show the worse case loss of an event.

Conclusion

Bi-directional OTDR measurements are a useful way of averaging losses measured in fiber links. Conventional processing may be used to give averaged loss results but an unacceptable amount of the fiber is obscured in short links such as those in LANs. The alternative method described here averages connector losses and effectively displays all of the fiber by removing reflection and dead zones. It is easily automated and is particularly suited for use in duplex links with a loop-back fiber.

References

- [1] FOTP ANSI/TIA/EIA-455-8 Measurement of Splice or Connector Loss and Reflectance using an OTDR.
- [2] DIVITA, P. and U. ROSSI. 1980. The Backscattering Technique: its field of applicability in fibre diagnostic and attenuation measurements. *Optical and Quantum Electronics* 11(17):17-22.
- [3] DERICKSON, D. *Fiber Optic Test and Measurement*. Chapter 11 Section 11.4.2